



GEAR TECH

We Build Automation



Hydraulic Road Blockers

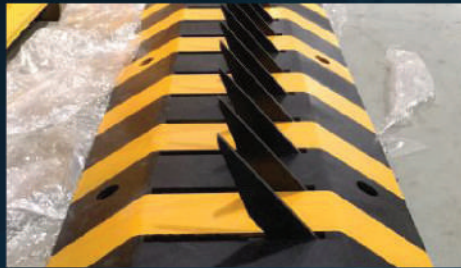

Tyre Killers

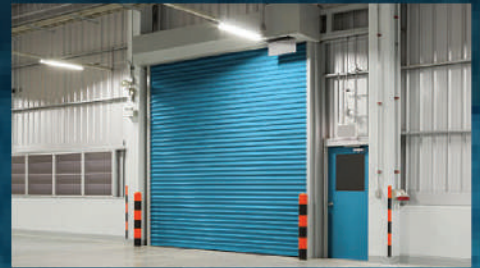

Automatic Industrial Shutters



Automatic Parking Barriers



Wheel Stoppers / Corner Pillars



Tripod / Flap Barriers



Automatic Sliding Doors



Personal Protective Equipments

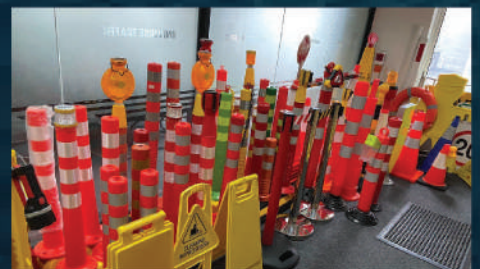

Parking Accessories



Fire Rated Doors



Sliding / Swing Gates



Home Security Systems

MORE PRODUCTS >>>



WHY CHOOSE US?

We have 90% client retention rate. What this means? That most of our clients continue to work us, after conducting their first business with us.

The reason is quite simple, we are flexible, fast-moving, and squeeze every bit of convenience from our innovative and locally manufactured security goods.

Rest assured, you can count one less zero on your operational bills. Because we are large-scale manufacturers, distributors, contractors, consultants and team of highly skilled engineers. Moreover, we have since worked for over 1000 satisfied clients and still counting.....

You might be thinking that where you fit in?

We customize our security solutions to your taste and hear you out at each stage of execution.



TABLE OF CONTENTS

1	HYDRAULIC ROAD BLOCKER	13	STEEL FABRICATION
2	HYDRAULIC BOLLARDS	14	TRIPOD / FLAP BARRIERS
3	TYRE KILLER	15	PARKING ACCESSORIES
4	MANUAL DELTA BARRIER	16	FIRE FIGHTING SYSTEMS
5	E-TAG PARKING BARRIER	17	SAFETY SHOES
6	UVSS SYSTEM	18	PERSONAL PROTECTIVE EQUIPMENTS
7	AUTOMATIC SLIDING DOOR	19	OTHER PRODUCTS
8	HOSPITAL DOORS	20	OUR CLIENTS
9	FIRE RATED DOORS	21	OUR PROJECTS
10	SLIDING / SWING GATES		
11	PARKING MANAGMENT SYSTEM		
12	AUTOMATIC ROLLING SHUTTERS		

[MORE DETAILS >>>](#)

HYDRAULIC ROAD BLOCKER



Surface mounted Hydraulic Road Blockers are designed specially for Entrance & Exit points. Hydraulic Road Blockers provides high anti-terror driveway protection level. Wide range of configurations enhance it's security levels according to projects & requirements.

Specifications:

- Lenth- 12f - Customize as per requirments
- Width- 2.5f
- Top Head Sheet- 12mm Checkered
- Front Sheet- 5mm
- Side Sheet- 12guage
- Internal Structure- 3inch, 6mm u channel & 3inch 6mm angle
- External Structure- 18guage sheet
- Paint- Red oxide & black berger paint with 3M reflector tape
- Hydraulic jack (Made in Italy)
- Hydraulic flexible pipe
- Hydraulic oil tank
- Hydraulic double action valve (Made in Japan)
- Hydraulic pump (Made in Italy)
- 3 phase motor (Siemen's Germany)
- Soundproof & Waterproof Cabinet Unit
- Multiple relays and magnet connectors
- Limit switch / Digital timer
- Up / Down switch button
- Traffic light Green & Red

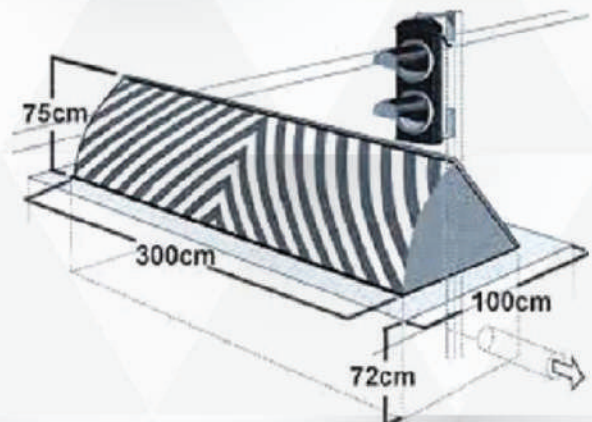

Ideal For:

Government insitutions, Commercial areas, Airport premises, Business centers, Industrial areas, Hotels, Financial institutes, Educational institutes, Sports complex,

HYDRAULIC BOLLARDS



Hydraulic bollards provides high level of security guaranteed access to pedestraint, Blocking the vehicles only. Enhance the entrances with their chrome finish.

Specifications:

- 8mm thickness of bollard with 10 inch dia
- Bollard rising height 2 to 3 feet adjustable
- 2mm thickness, 3inch angle and C channel structure
- 10mm top checked sheet
- Edge beam with tyflone rolling guide
- Anti rust Chrome Finish
- Hydraulic sound proof jack
- 3 phase 3Hp Siemens motor (Made In Germany)
- Operational speed 3 to 4 second (Up & Down)
- Manual release in case of electricity failure

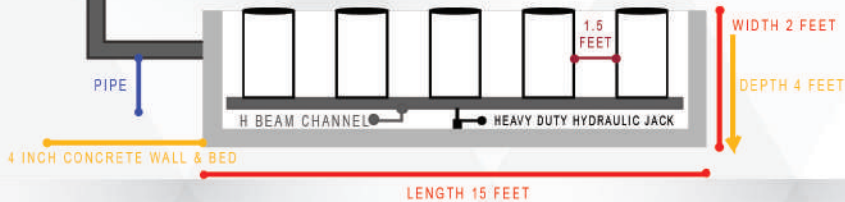

Ideal For:

Shopping Malls, Commercial areas, Airport premises, Business centers, Industrial areas, Hotels, Financial institutes, Educational institutes, Spa & Fitness centers,

TIRE KILLER



Tyre Killers are extremely heavy duty, built entirely of steel with components from steel plate. The product provides high security for sensitive areas against forced and unauthorized entry or exit of motor vehicles whereby tyres are destroyed when forced entry or escape is attempted.

Specifications:

- Solid killer spikes in 60o killing position.
- Killer height 100 mm.
- Shadow installation depth (250 mm).
- Carry load up to 50 Ton.
- Max. Passing velocity 30km/hr
- Anti corrosive.
- 3inch 2mm C Channel,
- 2Inch 6mm Angle,
- Spikes Thickness 12mm,
- In case Of Any Emergency, You Can Use Lever And All The Spikes Is Going To Be Down Automatically

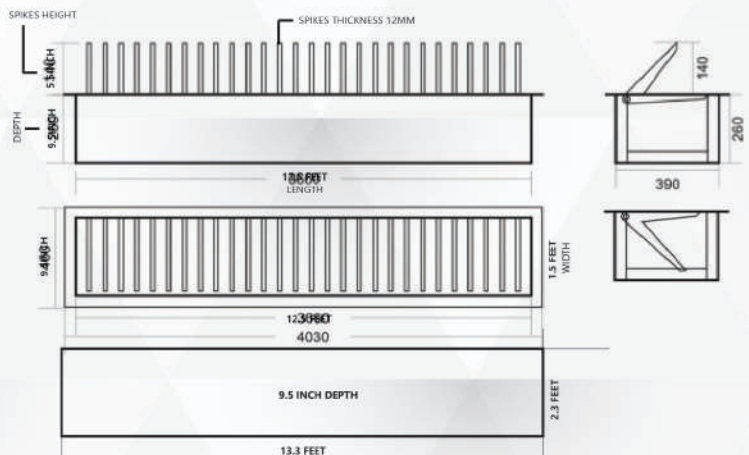
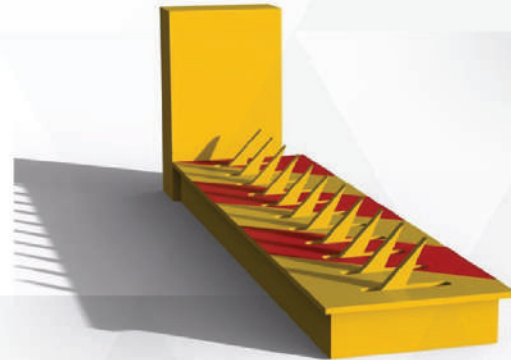

Ideal For:

Government insitutions, Commercial areas, Airport premises, Business centers, Industrial areas, Hotels, Financial institutes, Educational institutes, Sports complex, Parkings

MANUAL DELTA BARRIER



Manual delta barrier is used at government facilities, embassies and automotive sales facilities. Clear opening ranges from 10.5 to 24 feet (3,200 mm to 7,315 mm) are available to allow.

Specifications:

- Gross vehicle weight 15,000 lbs. (6,800 kg)
- Crash speed 30 mph
- Standard opening 3,200 ~ 7,315 mm
- Barrier Base Foundation Asphalt Emulsion
- Dimension 864 x 1800
- Anti rust Fine Finish
- Smooth Operation

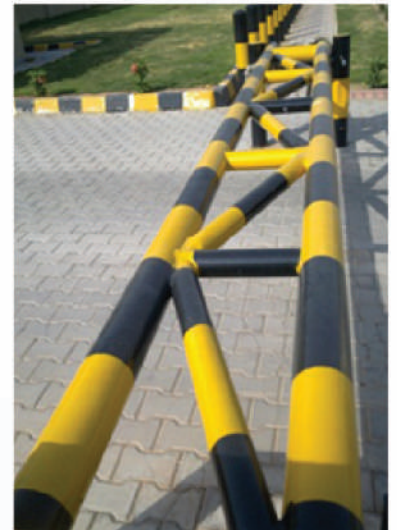

Ideal For:

Shopping Malls, Commercial areas, Airport premises, Business centers, Industrial areas, Hotels, Financial institutes, Educational institutes, Spa & Fitness centers,

E-TAG PARKING BARRIER

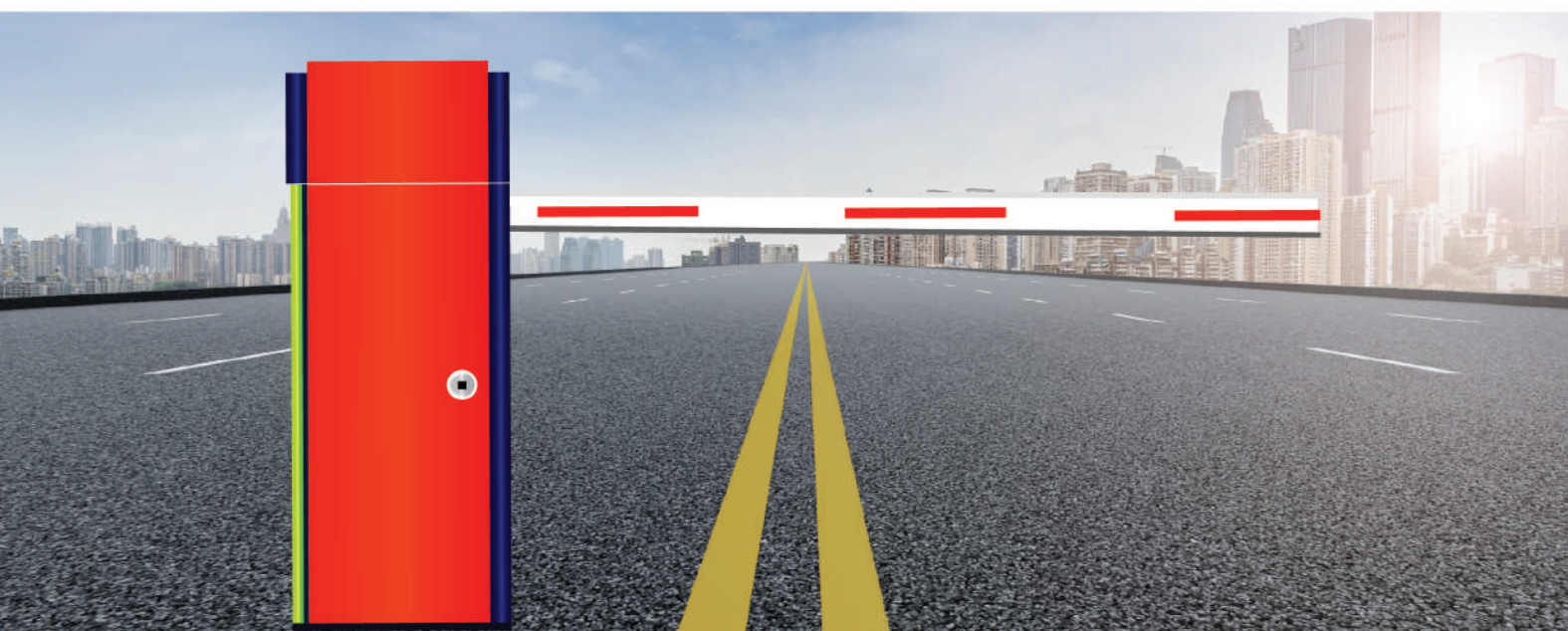

Electromechanical parking barriers also known as boom barriers, Which is operated by access controller using E-tags or via push button at visitors entry / exit points. Also used at toll plazas to stop the vehicles for toll collection. EVACS is effective to control access of vehicles in parking areas

Specifications:

- Net weight 55kg
- Rating voltage AC 220/110V \pm 10%
- Rating frequency 50/60Hz
- Rating Power 120W
- Opening/closing time 3s~6seconds
- Remote control distance (M) =30m
- Access controller (optional)
- Loop detector (optional)
- Signal light (optional)
- Ticket dispenser (optional)
- E-Tags (optional)
- Photocell sensor (optional)
- You can operate it with complete software as well.

Front view:

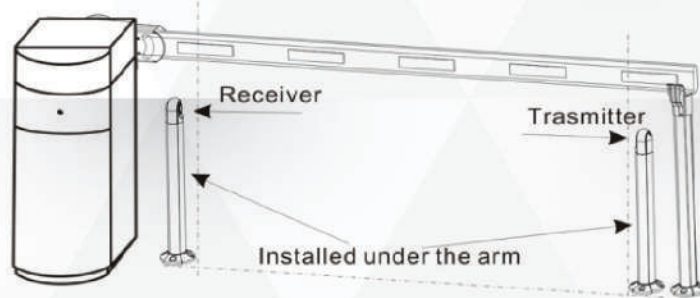

Traffic Light



UHF Reader



Loop Detector

Ideal For:

Government insitutions, **Commercial areas**, Airport premises, **Business centers**, Industrial areas, **Hotels**, Financial institutes, **Housing Societies**, **Sports complex**, **Parkings**

UNDER VEHICLE INSPECTION UVSS



If your premises are worth securing, it's worth looking into Under Vehicle Surveillance Systems (UVSS). Our UVSS solutions are designed to scan, monitor, and digitally record crisp, clear digital video images of the entire width of a vehicle's undersides

Specifications:

- 6mm Chequered Sheet Ramp Red Oxide & Yellow Paint
- Camera Box, Width 12mm Glass Window
- Gear Tech Night Vision Camera Panoramic View
- Camera For Driver With Pole Or Wall Clip
- External IR Light
- DVR 4 Channel
- Hard Disk 1TB

DESIGN NO 1

3D View

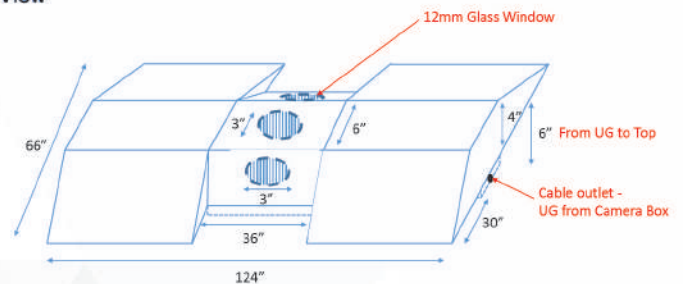

DESIGN NO 2



Ideal For:

Shopping Malls, Commercial areas, **Airport premises**, Business centers, Industrial areas, **Hotels**, **Financial institutes**, Educational institutes, **Spa & Fitness centers**, **Government Sectors**

AUTOMATIC GLASS DOORS



Sliding door system gives an aesthetically pleasing, yet highly functional entrance. Sliding door system comes complete with door leaf, safety devices, access control options and where required, side screens and overlights. Safe and easy to use, they are suitable for any entrance, from simple opening and closing

Specifications:

- Net weight 125kg
- Aluminium case 2.1 - 6.4m
- Opening speed 40-50s (Adjustable)
- Closing speed 20-30s (Adjustable)
- 8 bit micro computer
- Motor DC 12v
- Power voltage Ac 110v / 220v 50 - 60 HZ
- Power consumption 45w
- Detection angle 360 degree
- Push button (optional)
- Access control (optional)

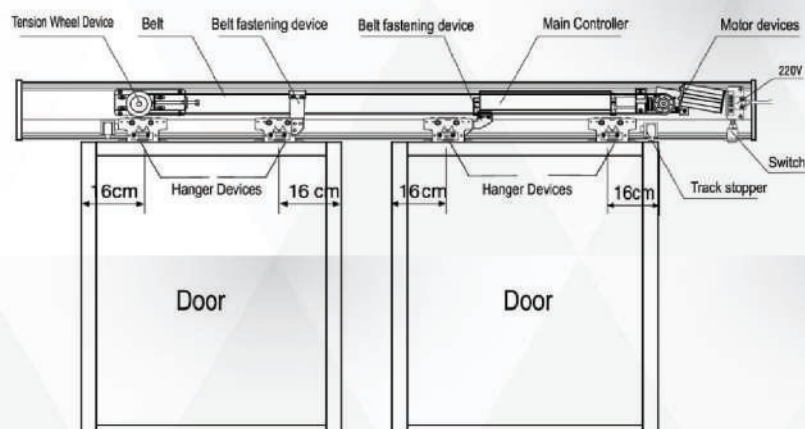

Trolley's



Push Button



Door Track

Ideal For:

Government insitutions, **Commercial areas**, Airport premises, **Business centers**, **Industrial areas**, **Hotels**, Financial institutes, **Housing Societies**, **Sports complex**, **Parkings**



Hospitals, clinics, care and nursing homes are all places built to look after people's health and well being and are used by people with reduced mobility, such as orthopedic and geriatric wards, or by people who may need to be moved around on wheel chairs or stretchers, Hospital doors used by the health industry is not an option, but it's essential requirement

Specifications:

- 16/18 SWG MS/SS Plain Sheet
- MS/SS U Section
- Diamond Jumbolon
- Polyutherene
- Foam Filling
- See Through Tempered/ Non Tempered Glass Window
- Panel Thickness 1.5 Inch / 2 Inch (Optional)
- Powder Coating For MS Material.
- Aluminium Track
- Rubber Belt
- Tafflon Wheels & Trolleys
- Belt Catchers
- End Gear
- Controller
- DC Motor
- Hand Sensor
- Foot Sensor
- Safety Sensors (optional)

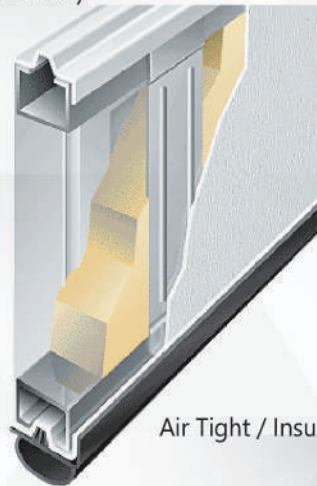

Air Tight / Insulated Door Panel



Door Track

Ideal For:

Hospitals, Commercial areas, Airport premises, Industrial areas, **Clinics**, **Pharmaceutical sectors**, **Food Industries**, Government Sectors

FIRE RATED DOORS



A fire door is a door with a fire-resistance rating (sometimes referred to as a fire protection rating for closures) used as part of a passive fire protection system to reduce the spread of fire and smoke between separate compartments. All fire doors must be installed with the appropriate fire resistant fittings, such as the frame and door hardware, for it to fully comply with any fire regulations

Specifications:

- Doors can be used in drywall
- Door Leaf Thickness: 42mm
- Material Thickness: 1mm–1.9mm
- Finish: Enamel Paint or Powder Coat finish
- Structure: High aesthetics and robust
- High quality standards
- Core type Rockwool
- Door type single / double leaf



Double Leaf Door



Single Leaf Door

Single Leaf Door Designs



Double Leaf Door Designs

Ideal For:

Government insitutions, Commercial areas, Airport premises, Business centers, Industrial areas, Hotels, Financial institutes, Housing Societies, Sports complex, Parkings



Our vast range of automatic gate products are from NICE. Who are the leading suppliers of home automation products across the world. Automatic sliding / swing gate makes your life comfortable, easy and beautiful. Forget the inconvenience of having to open and close your gate manually. Make a style choice, for you and your property.

Specifications:

- Increased Comfort & Security level
- Control with Smart remote
- Easy to open big and heavy gates
- Open while sitting in your car
- Safety sensor (optional)
- Elegant look
- Push button (optional)

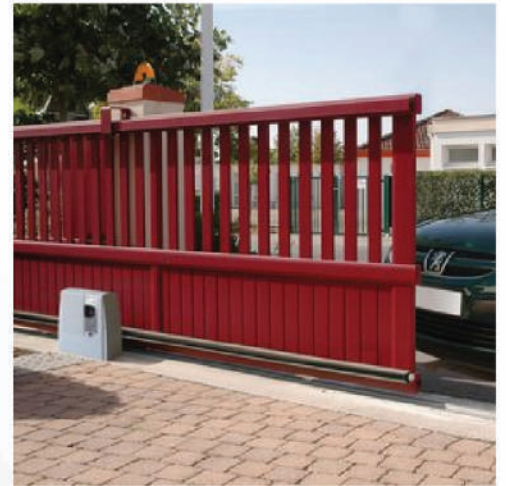

Automatic sliding gate



Automatic swing gate

Ideal For:

Hospitals, **Commercial areas**, Airport premises, **Industrial areas**, **Residential areas**, Educational institutes, Sports complex, Business centers



Find Your Parking Space On Entrance With our Unique Digital System. Access To your Parking Slot with Led Lights is Now to Easy with Geartech Latest System. Sensors will not detect anything except Cars.

Specifications:

- Find your space before entrance in parking area through led digital display board
- The numerical number size on led digital light will be 8 inch, easily visible for anyone on distance
- The sensors installed on parking slots only sense the cars, It will not sense any other motions
- On empty slot the parking light turns into green
- On filled parking slot parking light turns into red
- It will reduce stress with easy guidance.
- It's environmet friendly , Easy to understand and succesfull experienced system.

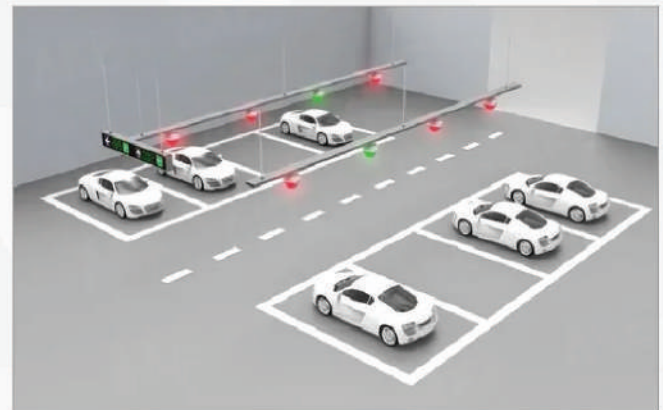

Ideal For:

Government insitutions, Commercial areas, Airport premises, Business centers, Industrial areas, Hotels, Financial institutes, Parking areas, Sports complex



Manufacturing according to your specific requirements, each of our Automatic Roller Shutter, Automatic Pvc high speed shutter, Polycarbonated shutter provides reliable service. Our highly flexible solutions also help improve safety and convenience. They can be customised to match your building with a wide range of colors and materials, then complemented with your choice of optional features and accessories.

Specifications:

- Automatic Rolling Shutters
- Automatic PVC high speed shutters
- Automatic Polycarbonated shutters
- Industrial sectional doors
- Push button (optional)
- Hand sensor (optional)
- Foot sensor (optional)
- Access control (optional)
- Signal light (optional)



Automatic high speed pvc shutters



Automatic rolling shutters



Automatic industrial sectional shutter



Automatic polycarbonated shutters

Ideal For:

Industrial sectors, Small industries, Food industries, Godowns, Warehouse, Shopping Malls, Commercial sectors

STEEL FABRICATION



The fabrication directly involve perfect design of item, calculate of all procedure to use for product, select correct material as per specification for item to work perfect and efficient and every step perfectly calibrate at the base of specific method of engineering.

Specifications:

- We provide complete heavy and light fabrications for your industries
- We provide complete fabrication of parking sheds with unique & modern designs.
- We provide complete structures of industries, backlet stairs and all the steel fabrications with architectural designs & measurements.



Stairs Structure



Ideal For:

Industrial Structures



Parking Sheds

Government insitutions, Commercial areas, Airport premises, Business centers, Industrial areas, Hotels, Financial institutes, Parking areas, Sports complex



Automatic tripod turnstile barriers, flap barriers and full height pedestrian barriers enhance the looks and entries of offices. It also provides security with the blockage of one side operation. RFID cards is essential to operate these barriers.

Specifications:

- Unlimited no of cycles
- Green and red light for indication
- RFID cards
- Built in access control
- Sleek and smart machines
- 1 year free maintenance
- Push button (optional)



Automatic flap barriers



Automatic tripod turnstile barriers

Ideal For:

Industrial sectors, Small industries, Food industries, Godowns, Warehouse, Shopping Malls, Commercial sectors, Educational institutes, Grocery stores, Shopping malls

PARKING ACCESSORIES



Geartech have a wide range of parking accessories, which includes different products. We're providing complete installation services to enhance the looks and security of your parking areas.

Products:

- Traffic cones in different sizes
- Delinators (Traffic bollards) in different sizes
- Cateyes (Plastic, Aluminium, Solar)



- Road marking CR & TP / Curve stone paint



Ideal For:
Parking areas, Highways, Industries, Commercial sectors



- Road signange with wide range of designs and layouts in different materials
- Reflectors 3M original HIV & Diamond grade

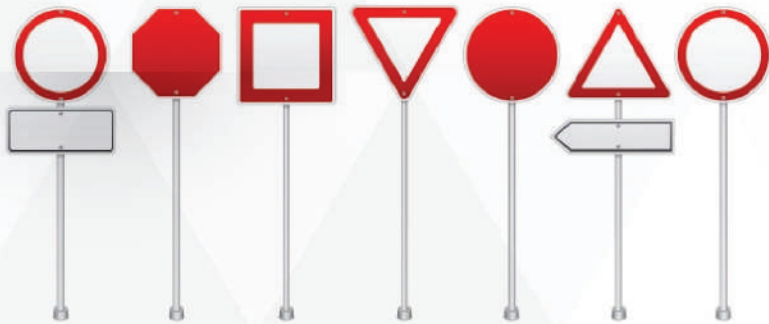

Pole Installations



Different Designs



PVC Indoor Signs

Ideal For:
 Parking Areas, Highways, Commercial sectors, Industrial plants

PARKING ACCESSORIES

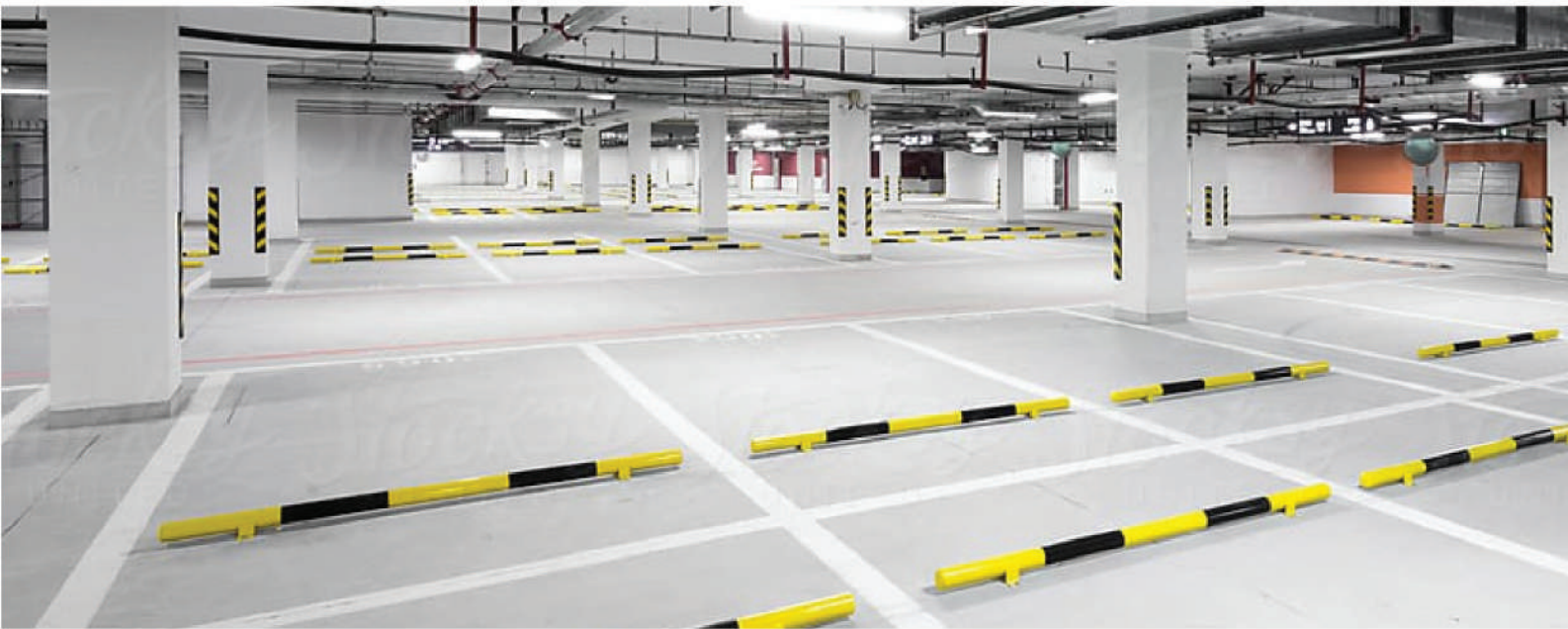

- Rubber corner pillars guard

FEATURES

- Prevent damage to both vehicles and buildings.
- Protect the edges of columns in structures
- Protect vehicles from common dents and scratches
- Relieves the tension of broken corners of pillars
- Physible for Shopping centres
- Suitable for Industrial parkings
- Suitable for hospital parkings

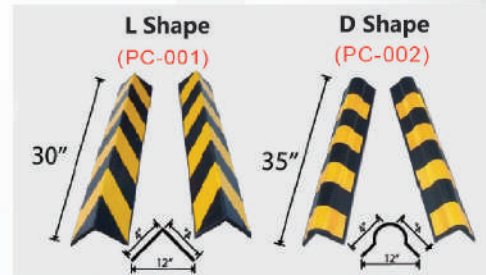

Model	Length	Width	Weight	Colour
GT-05-06	30''to35''	4''x4''	2.6-2.8Kg	Black&Yellow

- Rubber wheel stoppers

FEATURES

- Suitable for all parking areas specially designed for all light and heavy weight vehicles, Prevent from any accidents while parking car.

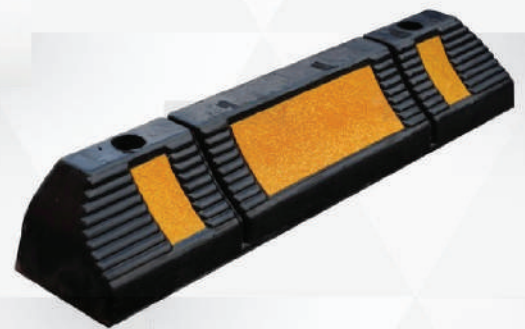

Model	Length	Width	Height	Weight
GT-01	24''	5''	4''	7 Kg

Ideal For:

Parking areas, Highways, Commercial sectors

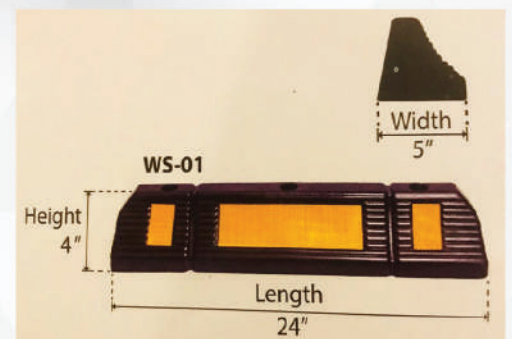



- Coloumn guards (Round)

FEATURES

- Prevent Damage
- Protect vehicles from scratches
- Flexible strip
- High grade reflector
- Best for edges, sharp turns
- High quality product

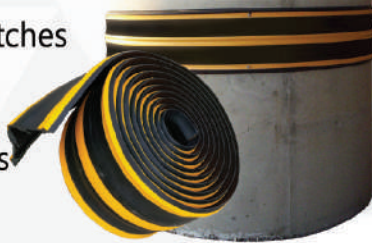

- Speed humps Rubber + Aluminium

FEATURES

- On roads where the speed limit is not obeyed
- Hazardous intersections
 - Dangerous curves or bends
 - Residential areas, including complexes and estates



Ideal For:

Parking areas, Highways, Commercial sectors



- Dock fenders

FEATURES

- Prevent damage to both vehicles and buildings.
- Protect the dock gates
- Protect vehicles from common dents and scratches
- Extra thick rubber fenders

- Convex parking mirrors

FEATURES

- Outdoor & indoor convex mirrors
- Available with cap & without cap
- With wall brackets
- Fixing with stand (optional)
- High quality product



Ideal For:

Parking areas, Commercial buildings, Industries



- Fire safety systems

PORTABLE FIRE EXTINGUISHERS

- DCP
- CO2
- Foam
- Water
- Wet Chemical

FIRE ALARM SYSTEMS

- Intelligent Addressable Fire Detection and Alarm System
- Smoke & Heat Detection
- Very Early Warning Fire Detection Systems
- Flame & Gas Detection
- PAVA System

FIRE WATER BASE EXTINGUISHING SYSTEM

- Sprinkler System
- Deluge System
- Pre-action System
- Water Mist System (High & Low)
- Hydrant System
- Fire Pump System

FIRE SUPPRESSION SYSTEMS

- Low/Medium/High Foam Expansion System
- DIFFS • NOVEC 1230 System
- FM 200 System
- CO2 System (LP/HP)
- Inert Gas System
- Wet (Kitchen Hood) & Dry Chemical System
- Aerosol Fire Suppression System



SAFETY FOOTWEAR

ARTICLE: GT-DD/LCN

STANDARD: EH-S3

ANTI SLIP, TOE CAP, PUNCTURE RESISTANT SOLE, CLOSED HEEL AREA, FUEL RESISTANCE SOLE, ANTI-STATIC PROPERTIES, ENERGY ABSORPTION IN HEEL AREA, WATER RESISTANT, PROFILED SOLE.



We're manufacturer of safety shoes, having a wide range of articles according your floor requirements. Following the standards of **S1, S2, S3 - EN 20345**. We're providing the quality product to our clients. We've both low price range articles and high export quality products.

Specifications:

- Leather uppers
- PU sole, rubber sole, PVC sole, Dual density Sole PU + PU, DMS sole, IMS sole
- Steel toe 200J
- Mid sole plate (optional)
- Comfortable insocks
- Synthetic linings
- Hooks laceup, Eyelet laceup, buckle
- More then 100 articles



EVERSAFE
SAFETY SHOES

GALAXY
SAFETY SHOES

JAGUAR
SAFETY SHOES

ROCKHARD
SAFETY SHOES

Ideal For:

Industries, Construction sites, Power plants, Chemical sectors, Oil & petroleum sectors



We're dealing in complete range of PPE's (personal protective equipments) products. We're manufacturing Safety shoes, Uniforms and 75% personal protective equipments in Pakistan.

Products:

- Protective clothing
- Safety footwear
- Head protection industrial helmets
- Head protection fire helmets
- Face shields
- Ear muffs, Ear plugs
- Safety mask
- Safety goggles
- Safety gloves
- Fire safety equipments
- First aid box
- Safety harness belts
- Disposable kits



Ideal For:

Industries, Construction sites, Power plants, Chemical sectors, Oil & petroleum sectors

OTHER PRODUCTS

We've a range of other products which falls in different safety & security category.



Access Control Devices



Automatic Door Locks



CCTV Cameras



Wireless Security Alarm Systems



Electric Fence



Razor Wire



Walk Through Gates



Metal Detectors



X-RAY Baggage Scanner

OTHER PRODUCTS



Under vehicle Search Mirror



Sensors, UHF reader & Accessories



Traffic Lights

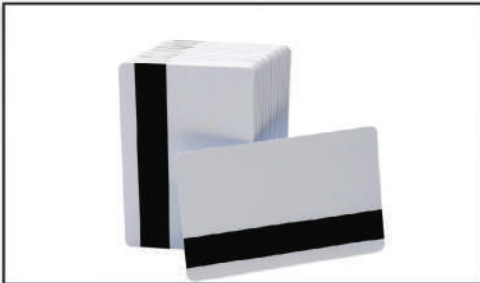

RFID Cards and E-Tags



Outdoor / Indoor LED Screens



Acoustic Sound Systems

IIHS CRASH TESTED US LISTED ISO 9001



OUR CLIENTS



engro corp



China Embassy



QADRI Group



Packages Mall



Ghani

Pakistan's No. 1 Glass Brand



Jotun Protects Property



BAHRIA TOWN



NADRA PAKISTAN



mindstorm STUDIOS



ORIENT



AL-FATAH



Hotel One



Change your life

archi-cubes Architects & Interior Designers



Ibrahim Group



AVENUE MALL Discover The Difference



Rupali Polyester Ltd



AL-JALIL DEVELOPERS



OUR PROJECTS

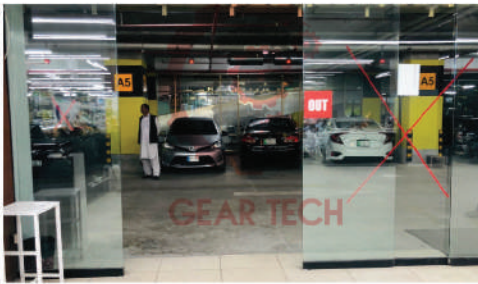
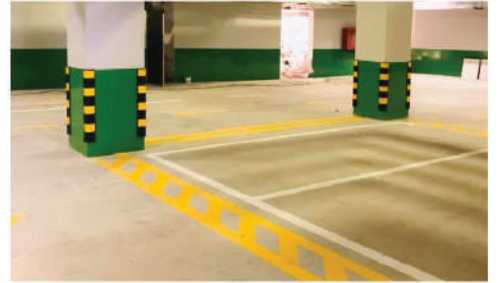



GEAR TECH

LAHORE (Head Office)

Office - 309, Moon Tower 5th Floor, Model Town Block M, Lahore
Ph: +42 35219086 Cell: +92 332 4644569 +92 333 3332940
E-mail: geartech.pk@gmail.com info@geartech.pk

KARACHI

Office: E-12, 6th Floor Mayfair Centre Saddar, Karachi
Ph: +21 32244073 Cell: +92 336 8511423
E-mail: geartech.karachi@gmail.com